

NEW

Radiometrix

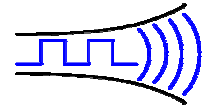

Hartcran House, 231 Kenton Lane, Harrow, HA3 8RP, England
Tel: +44 (0) 20 8909 9595, Fax: +44 (0) 20 8909 2233

21 August 2008

NBEK-000-xxx

NBEK Controller As 1200 Baud Modem

The Narrow band Evaluation Kit (NBEK) IC can be used as 1200baud half-duplex serial modem suitable for narrow band receivers, transmitters and transceivers (or any RF modules with >5kbps data rate). It takes care of preamble, synchronisation, bit balancing and error checking and enables a transparent radio data link to be established between radio devices

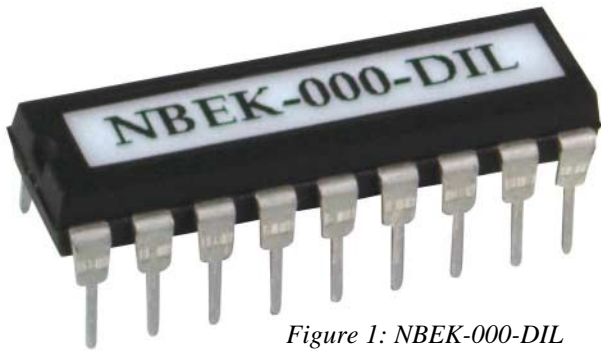

Figure 1: NBEK-000-DIL

This is a half duplex unit, so collisions between transmitted and received packets must be dealt with by the user.

Provided no two devices attempt to transmit simultaneously no further restrictions on data transmission need be made, as all transmit timing,

valid data identification and data stream buffering is conducted by the unit. Synchronisation and framing words in the packet prevent the receiver outputting garbage in the absence of wanted RF signal or presence of interference.

Supports 1200 baud asynchronous data: 1 start bit, 8 data bits, 1 stop bit.

With typical microcontrollers and UARTs, direct connection is usable as shown on figures 2 & 3.

To connect to a true RS232 device, inverting level shifters must be used (MAX232 type are ideal, but simple NPN/PNP transistor switches often suffice as used in the application circuits figures 4 & 5).

Features

- Operating voltage (temperature): 5V for standard version (-40°C to +85°C)
- Maximum usage of the range capability of an RF module
- Adequate preamble to settle data slicer in the receiver
- Extra wake up preamble to allow for transmitter power up time requirements
- Differential Manchester encoding of address, data and checksum
- Synchronisation codes and checksum to reduce false triggering on noise
- Suitable to be used with Narrow Band FM radio modules
- Serial modem baud rate at 1200bps (half-duplex)
- Addressable point-to-point

Applications

- PDAs, organisers & laptops
- Handheld / portable terminals
- EPOS equipment, barcode scanners
- In-building environmental monitoring and control
- Remote data acquisition system, data logging
- Fleet management, vehicle data acquisition

User Interface

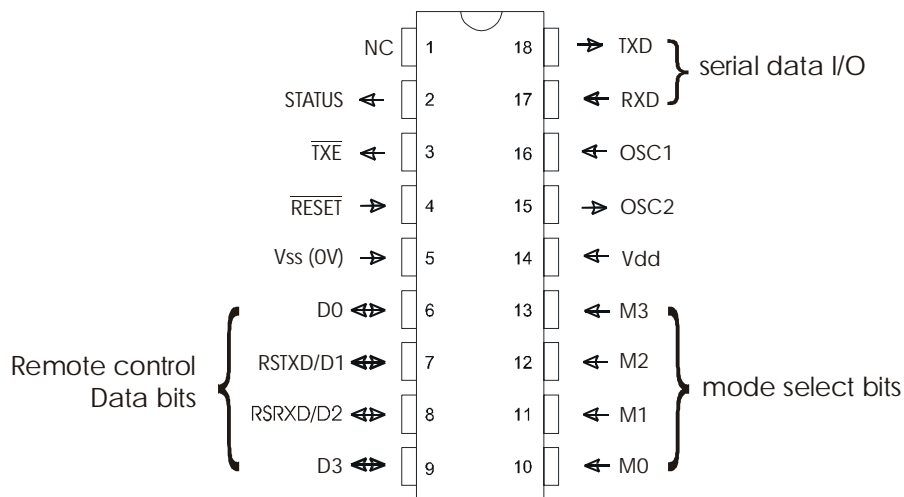

Figure 2: package type, 18-Lead Plastic Dual In-line (PDIP - 300mil wide body)

Pin description:

Pin	Name	I/O	Function
1	NC	-	No Connection
2	STATUS	out	High indicates data received or in rx FIFO buffer
3	$\overline{\text{TXE}}$	out	Active low enable transmitter
4	$\overline{\text{RESET}}$	in	A 10k Ω pullup to VCC must be provided
5	0V	-	Supply ground
6	D0	in/out	Data bit 0 value during Control44 encoder / decoder mode
7	D1/RSTXD	in/out	Data bit 1 value during Control44 encoder / decoder mode Inverted RS232 datastream in, 1200 baud
8	D2/RSRXD	in/out	Data bit 2 value during Control44 encoder / decoder mode Inverted RS232 datastream out, 1200 baud
9	D3	in/out	Data bit 3 value during Control44 encoder / decoder mode
10	M0		Mode select LSB -
11	M1		Mode select
12	M2		Mode select
13	M3		Mode select MSB
14	Vcc	-	5V (regulated power supply); Decouple with 0.01 μF close to IC
15	OSC2	out	connect to 3.58MHz crystal
16	OSC1	in	connect to 3.58MHz crystal
17	RXD	in	Baseband input from receiver data output
18	TXD	out	Baseband output to transmitter data input

Notes:

- No connections at all may be made to 'nc' pin
- TXD, RXD, RSRXD, RSTXD and STATUS are 5V CMOS logic level
- Some Radiometrix transmitters require 3V logic levels on their transit data inputs:
a divider (4.7k Ω series, 10k Ω to ground) on the TXD pin is needed
- In RX operation, RXD becomes a high impedance
- After pulling TXE low (active), the coder allows about 50mS for TX to power up and settle
- RSTXD (7) has no pullup. If the device is only used for receive, then tie this pin to VCC
- Vcc must be a 5v regulated supply (4.75 - 5.25V). At this oscillator speed the PIC will not operate reliably at 3V
- Pin 3 has no pullup. It is used to enter 'setup' mode (see below)
- Without external loads the chip draws less than 5mA from 5v
- STATUS goes high when valid data is present in the receive buffer.
- OSC1, 2 require a 3.58MHz fundamental mode crystal, a series 100 Ω resistor from OSC2, and a pair of 15pF caps : from the crystal pins to 0V

Mode selection

The mode select bits M0-M3 put NBEK IC in to one of 16 operating modes, including modem mode.

MODE	H=VDD L=0V (inverted logic)			
	M3	M2	M1	M0
0	HHHH			Receive mode
1	HHHL			Un-modulated Transmission for testing carrier frequency, power, spuri
2	HHLH			250Hz (500bps) square wave Modulated Transmission
3	HHLL			1250Hz (2.5kbps) square wave Modulated Transmission
4	HLHH			Pseudorandom NRZ stream modulated Transmission
5	HLHL			Transmitter and Receiver turned ON and OFF periodically at 100ms interval
6	HLLH			RESERVED for future use
7	HLLL			RESERVED for future use
8	LHHH			Continuous Control44 Transmission of Address=0 and Data=D3, D2, D1, D0
9	LHHL			Control44 Transmission of Address=0 and Data=D3, D2, D1, D0 If either Data is changed or RESET (Trigger) switch is pressed.
10	LHLH			Control44 Reception with Momentary Output. (paired with Mode 8)
11	LHLL			Control44 Reception with Latched Output. (paired with Mode 9)
12	LLHH			Transmits CTR44 Test Packet, Receive Echoed Packet (Radar Mode – Master)
13	LLHL			Receive CTR44 Test Packet, Re-transmit it back to Sender (Echo Mode – Slave)
14 (Modem)	LLLH			I1200 type 1200 baud Dumb Modem for bit balanced serial data transmission
15	LLLL			RESERVED for future use

Notes:

1. Mode 12 and 13 require Transceiver
2. In Mode 12, a test packet is transmitted, then the unit switches to Receive mode for 100ms before repeating.
3. Data sequence of 8 (D3=L, D2=H, D1=H, D0=H), 4, 2, 1 (D3=H, D2=H, D1=H, D0=L) is cycled through with each transmission.
4. In Mode 13, the unit idles in Receive mode. When a valid CTR44 burst is received the unit keys up the Transmitter and re-transmits this CTR44 burst back to sender in Mode 12.

Operating principle of modem

This device is a simplex link handling a 1200 baud asynchronous datastream (1 start, 8data, 1stop). Buffering in the transmit end handles TX startup timing requirements, while the presence of sync codes in the transmitted bursts prevents the receiver from outputting garbage in the presence of noise. No error correction or retransmission of lost packets is supported. To operate with proper +/-12V RS232 levels an external buffer (such as a MAX232) will be needed

Operation: Serial interface

Both transmit and receive modems implement a 32 byte software FIFO. At the transmit end this is used to allow for the transmitter start up time (about 32mS), while on receive it buffers arriving packets to the constant output data rate. All timing and data formatting tasks are handled by the software. The user need not worry about keying the transmitter before sending data: the link is entirely transparent.

For transmission across the link data is formatted into packets, each comprising 3 bytes of data and a sync code. If less than 3 bytes are in the transmit end FIFO then a packet is still sent, but idle state replaces the unused bytes. When the transmit end FIFO is completely emptied, then the transmitter is keyed off .

Operation: Radio interface

Raw data is not fed to the radios. A coding operation in the transmit mode, and decoding in the receive mode, isolate the AC coupled, potentially noisy baseband radio environment from the datastream.

The radio link is fed a continuous tone by the modem. As in biphas codes, information is coded by varying the duration consecutive half-cycles of this tone. In our case half cycles of 500µs (a long, or L) and 250µs (a short, or S) are used.

In idle (or 'preamble') state, a sequence of Ls is sent (resembling a 1kHz tone).

A packet comprises the Synchronising (or address) part : LSSSSSSSSSSSL followed by the Data part, made up of twelve Groups (of four half cycles duration). Each Group encodes 2 data bits, so one byte is encoded by 4 Groups.

Although there are 16 possible states for a four half cycle group (from SSSS to LLLL), only four of the possible states are used for valid data:

All other possible group combinations (except LLLL) are void, and result in the entire packet being rejected by the receiver software as a noise artifact. Idle state tone (LLLL) is decoded as null data, but does not void the packet, as a packet containing less than 3 bytes still needs to be decoded.

The advantage of using the above coding technique:

- 1.Ease of decoding: Unlike biphas, where a bit is coded as either a long half cycle or a short cycle, here all half cycles are detected separately.
2. Inherent error detection: Although only 14 sync/address 'bits' (halfcycles) are used, the following 48 'bits' (halfcycles) only code 24 real data bits, leading to enhanced noise/error discrimination (the equivalent of 5 more sync bits).
3. Comparable spectral efficiency: For a maximum transmitted baseband frequency of 2kHz, a 3 byte packet is sent in 22ms. An equivalent biphas coded packet (comprising 19 sync + 24 data + 3 null flags) at 2kbits/sec takes 23ms

Application Circuits

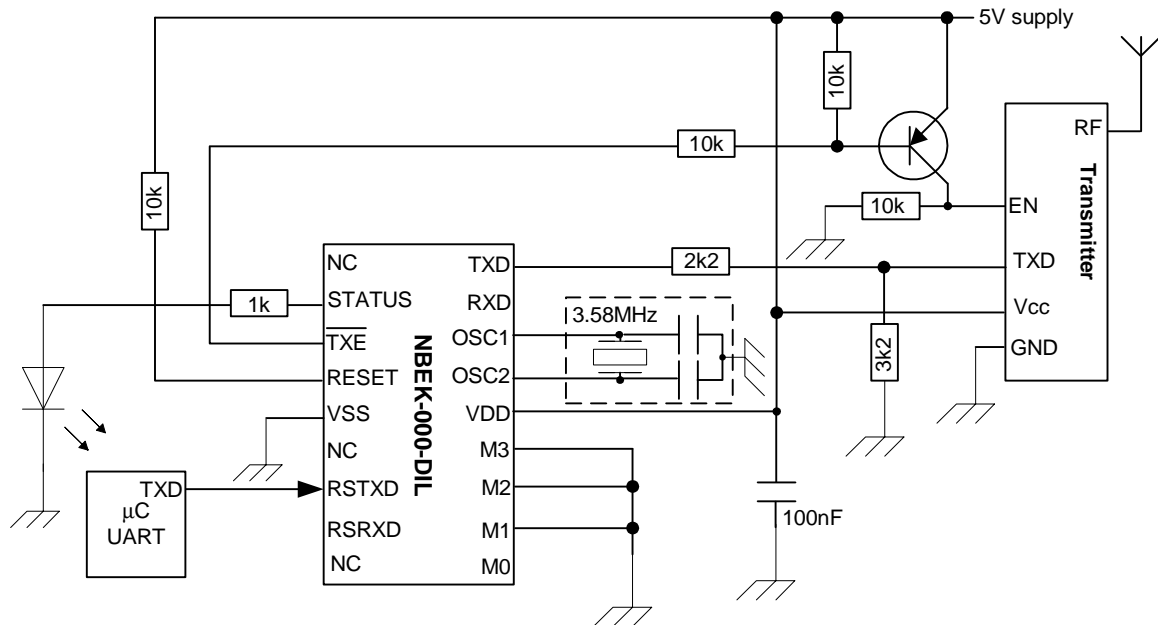

Figure 2: NBEK IC interfaced to a Transmitter (e.g. TX1)

- Note:**
1. Transmit keyed when valid serial data is present at the RSTXD input, so no separate TX control needed
 2. OSC1,2 require a 3.58MHz ceramic resonator with internal capacitors like Murata CSTLA3M58G55-B). If a 2 pin resonator or crystal is used, then two 15pF caps are needed: one from OSC1 to 0V; one from OSC2 to 0V

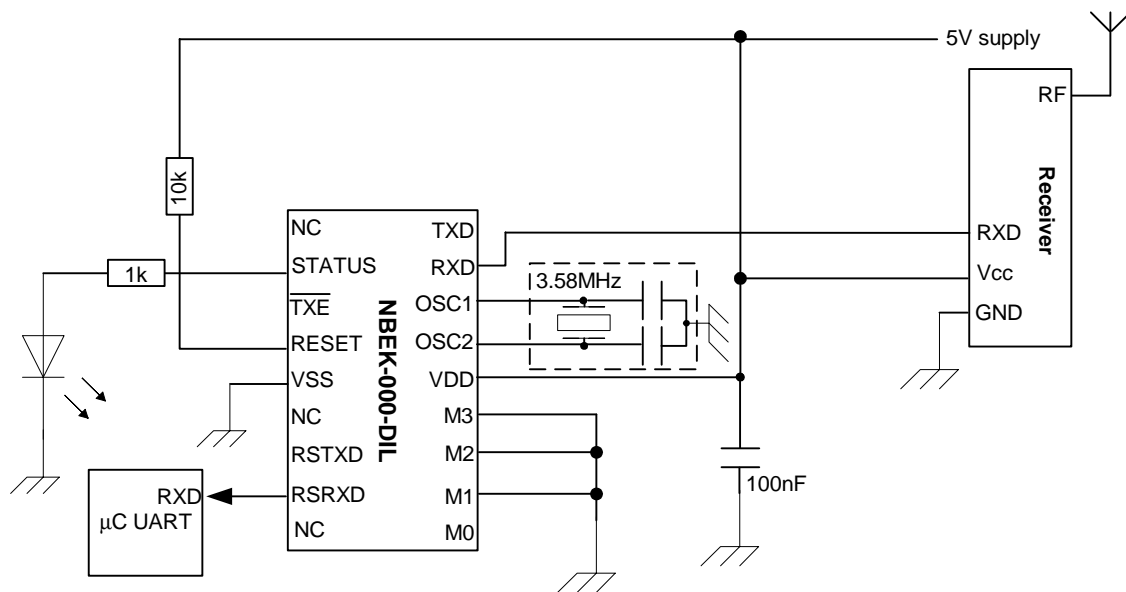

Figure 3: NBEK IC interfaced to a Receiver (e.g. NRX1)

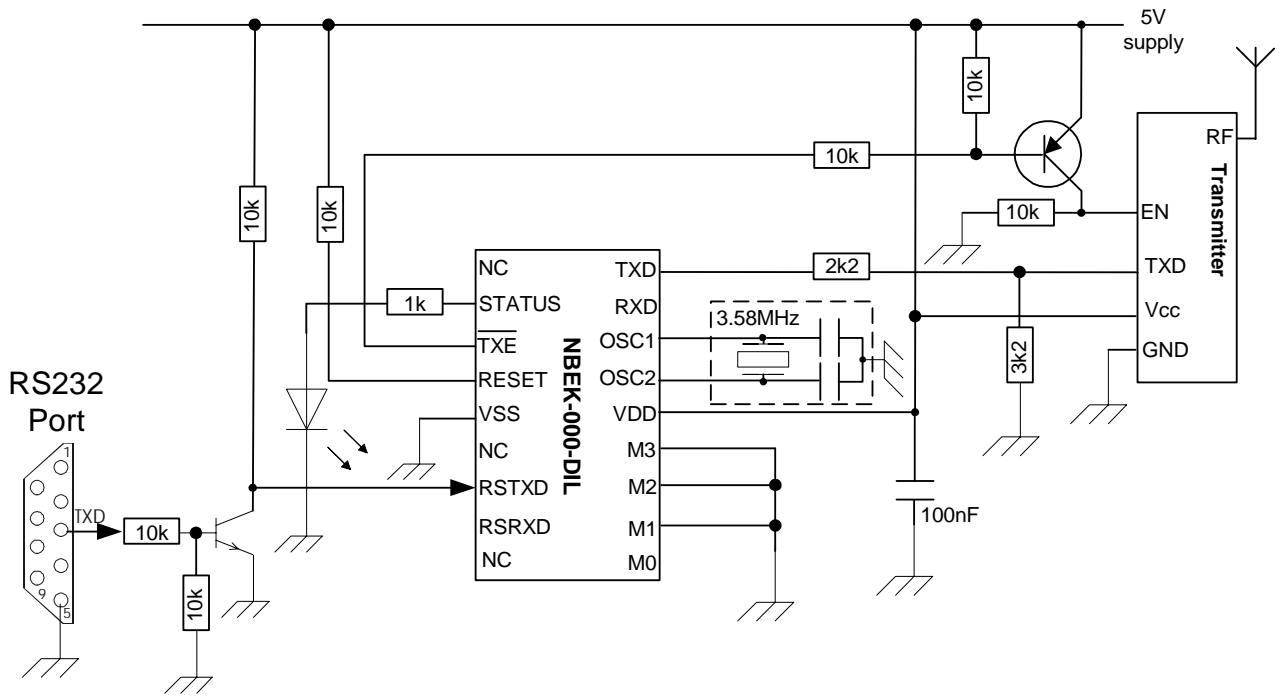

Figure 4: RF Transmitter (e.g. TX1) + NBEK IC interface for RS232 data transmission

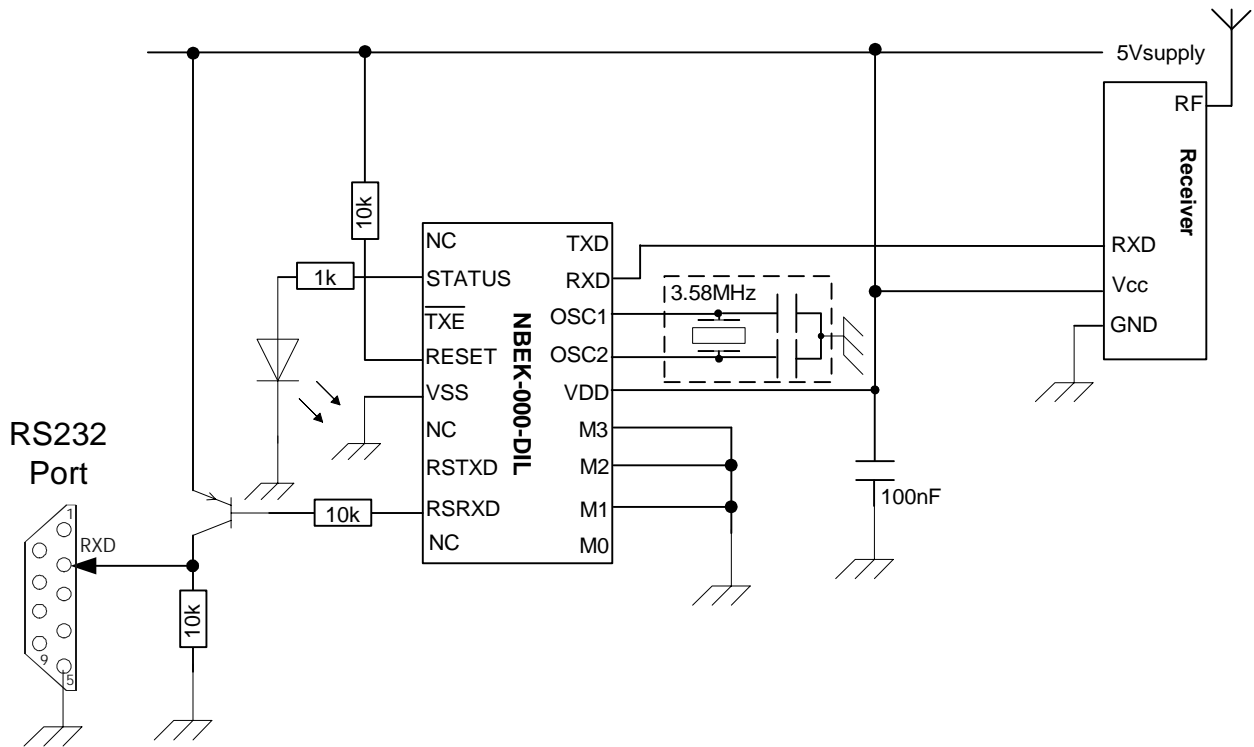

Figure 5: RF Receiver (e.g. NRX1) + NBEK IC interface for RS232 data reception

Ordering Information:

The NBEK controller IC can be ordered separately with equal number of radio modules.

- NBEK-000-SS - Shrink Small Outline
- NBEK-000-SO - Small Outline
- NBEK-000-DIL - Plastic Dual In Package

Radiometrix Ltd
Hartcran House
231 Kenton Lane
Harrow, Middlesex
HA3 8RP
ENGLAND
Tel: +44 (0) 20 8909 9595
Fax: +44 (0) 20 8909 2233
sales@radiometrix.com
www.radiometrix.com

Copyright notice

This product data sheet is the original work and copyrighted property of Radiometrix Ltd. Reproduction in whole or in part must give clear acknowledgement to the copyright owner.

Limitation of liability

The information furnished by Radiometrix Ltd is believed to be accurate and reliable. Radiometrix Ltd reserves the right to make changes or improvements in the design, specification or manufacture of its subassembly products without notice. Radiometrix Ltd does not assume any liability arising from the application or use of any product or circuit described herein, nor for any infringements of patents or other rights of third parties which may result from the use of its products. This data sheet neither states nor implies warranty of any kind, including fitness for any particular application. These radio devices may be subject to radio interference and may not function as intended if interference is present. We do NOT recommend their use for life critical applications.

The Intrastat commodity code for all our modules is: 8542 6000

R&TTE Directive

After 7 April 2001 the manufacturer can only place finished product on the market under the provisions of the R&TTE Directive. Equipment within the scope of the R&TTE Directive may demonstrate compliance to the essential requirements specified in Article 3 of the Directive, as appropriate to the particular equipment.

Further details are available on The Office of Communications (Ofcom) web site:

<http://www.ofcom.org.uk/radiocomms/ifi/>

*Information Requests
Ofcom
Riverside House
2a Southwark Bridge Road
London SE1 9HA
Tel: +44 (0)845 456 3000 or 020 7981 3040
Fax: +44 (0)20 7783 4033
information.requests@ofcom.org.uk*

*European Radiocommunications Office (ERO)
Peblingehus
Nansensgade 19
DK 1366 Copenhagen
Tel. +45 33896300
Fax +45 33896330
ero@ero.dk
www.ero.dk*